



### Descrizione

Il modello SL16 è un prodotto compatto e consente di proteggere la lanterna semaforica durante la movimentazione. Utilizzabile con centraline Dual (versione countdown no) e MPB.

### CARATTERISTICHE OTTICHE

Sorgente luminosa	LED	
Ottica	Monofacciale	
Colori	Verde - Ambra - Rosso	
Proiettori	2x200 mm 1x300 mm	3xBasic 211 1xCountdown
Durata gruppo ottico	> 50'000 ore	

### CARATTERISTICHE ELETTRICHE

Alimentazione	12 Vdc (11 ÷ 15 Vdc)	
Consumi	3 W	5.5 W
Classe di isolamento	Classe III	

### CARATTERISTICHE MECCANICHE

Temperatura operativa	-10°C ÷ +55°C	
Grado di protezione IP proiettori	IP55	IP65
Grado di protezione IP carrello	IP54	
Peso	25 Kg (batterie escluse)	
Dimensioni (Aperto)	787 x 455 x 2200 mm	780 x 455 x 2210 mm
Dimensioni (Chiuso)	885 x 440 x 980 mm	940 x 440 x 730 mm
Altezze regolabili	1950/2075/2200 mm	1960/2085/2210 mm
Materiali proiettori	Policarbonato (lente e corpo)	Policarbonato (lente); PA6 (corpo)
Materiale carrello	Acciaio zincato verniciato	



Rev. 3.0

29/09/2023

Approved TEC

Approved AQ

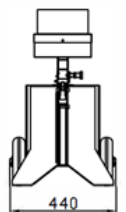
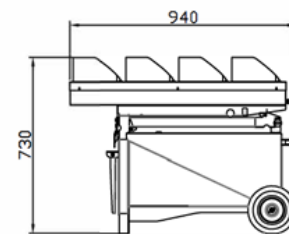
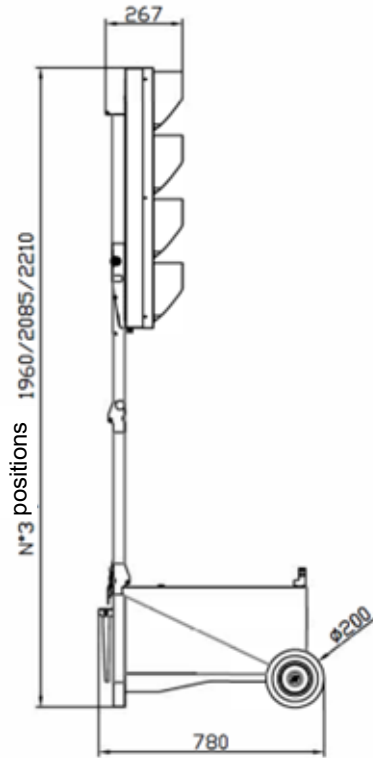
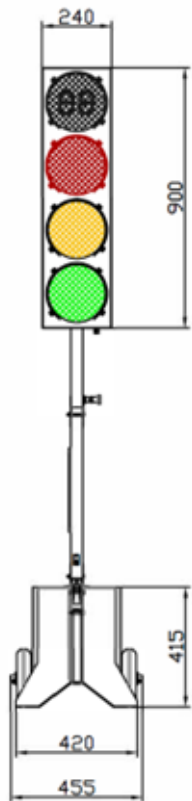
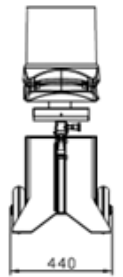
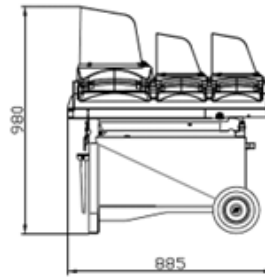
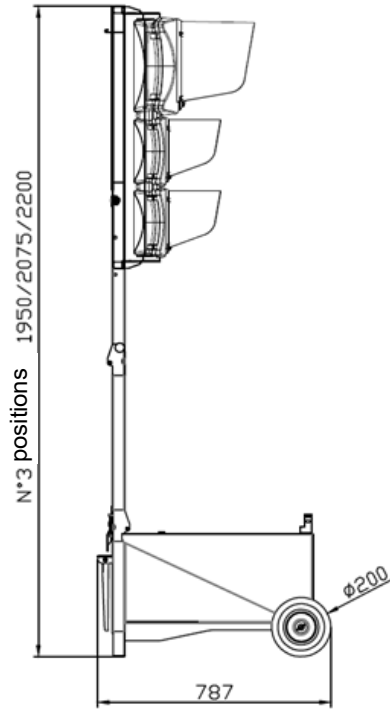
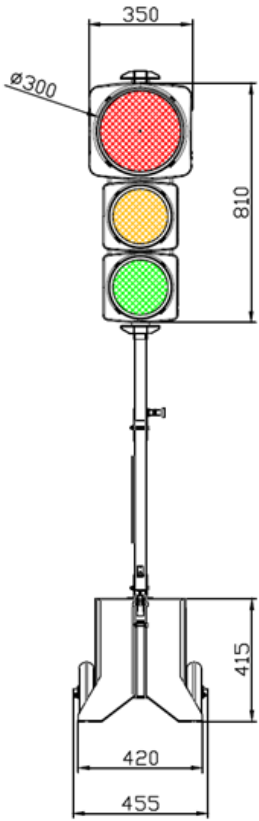

Rev. 3.0  
29/09/2023

Approved TEC

Approved AQ